

Pangea



Art. 2005A

Art. 2005ALE

Art. 2005ACR

Art. 2005ASG

Art. 2005AVL



Campo di applicazione

Installazione interna

Field of application

Internal installation

Caratteristiche

Mobile: Bilaminato

Maniglia: Nichel spazzolato lucido

Vasca: Materiale plastico, forabile per installazione rubinetto

Sportello: scorrevole, con angoli arrotondati

Asse: Pino verniciato

Scarico: Sifone autopulente con attacco lavatrice, piletta, tappo, troppopieno e particolari inox

Piedini: Regolabili in altezza, 15 mm

Features

Furniture: Bilaminated wood

Handle: Brushed polished nickel

Basin: Plastic material, it can be punched to install the faucet

Door: Sliding, with rounded angles

Washing board: Varnished pine wood

Drain: Self-cleaning siphon with washing-machine coupling, drain, plug and overflow with stainless steel details

Feet: Adjustable height, 15 mm

Art. 2029

Vasca in resina speciale 45x60 cm
Plastic basin 45x60 cm

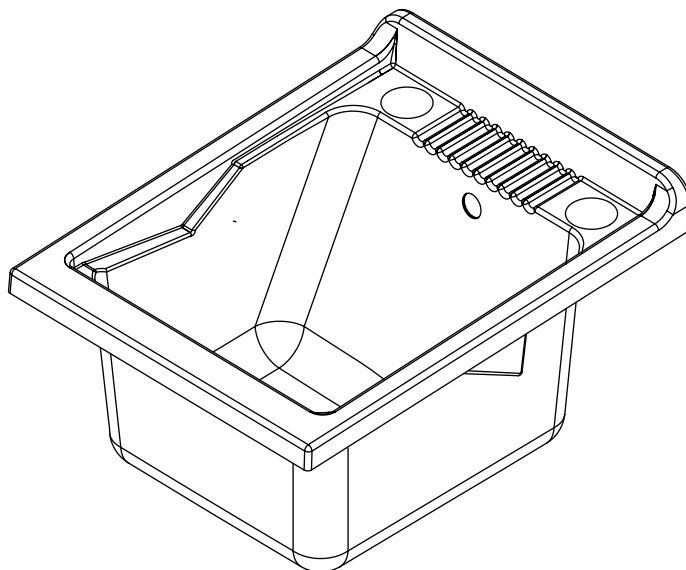

Dimensioni (mm)- Dimensions (mm)

