

Futura



Art. 2009FB



Art. 2009FCG



Art. 2009FMV

Campo di applicazione

Installazione interna

Field of application

Internal installation



Caratteristiche

Mobile: Bilaminato

Maniglie: Nichel spazzolato lucido

Vasca: Materiale plastico, forabile per installazione rubinetto

Sportelli: con angoli arrotondati

Asse: Pino verniciato

Scarico: Sifone autopulente con attacco lavatrice, pileta, tappo, troppopieno e particolari inox

Piedini: Regolabili in altezza, 15 mm

Zoccolo estraibile per una facile pulizia: in PVC, ricoperto con lamina in alluminio

Cerniere: a chiusura rallentata

Pianale salvafondo: in alluminio

Features

Furniture: Bilaminated wood

Handles: Brushed polished nickel

Basin: Plastic material, it can be punched to install the faucet

Door: With rounded angles

Washing board: Varnished pine wood

Drain: Self-cleaning siphon with washing-machine coupling, drain, plug and overflow with stainless steel details

Feet: Adjustable height, 15 mm

Removable base for an easier cleaning: made of PVC, with aluminum laminated finish

Hinges: with soft closing

Aluminum lower tray

Art. 2032

Vasca in resina speciale 60x45 cm
Plastic basin 60x45 cm

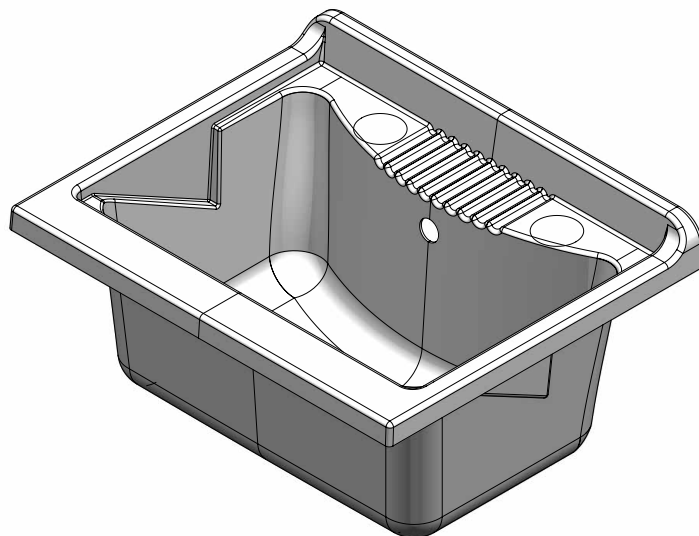

Dimensioni (mm)- Dimensions (mm)

